



*A. Uberti* S.p.A.

Via Artigiani, 1 - Gardone V.T. (Brescia) - ITALY

## Instruction Manual

BEFORE REMOVING THE FIREARM FROM THIS PACKAGE,  
READ & UNDERSTAND THE PRECAUTIONS IN THE  
INSTRUCTIONS MANUAL

### 1860 HENRY MOD.

#### SPECIAL SAFETY INSTRUCTIONS

- 1) Uberti lever action rifles should never be carried with a cartridge in the chamber.
- 2) Carrying this style of rifle with a cartridge in the chamber can result in an accidental discharge if the firearm is accidentally dropped or if the hammer is struck.
- 3) The lever locking mechanism is designed to prevent an accidental discharge. However, no mechanical device is foolproof and, accordingly, these procedures must be followed.
- 4) Due to the fact that in a tubular magazine rifle the cartridges are stacked one behind the other, only factory ammunition should be used.
- 5) We recommend against using old ammunition in these rifles as primers, powder and brass cartridge cases can deteriorate and cause damage to the rifle or injury to the shooter or others.
- 6) Uberti assumes no liability for incidents occurring through the use of reloaded ammunitions.  
Use **ONLY COMMERCIALY** loaded cartridges that have been loaded in accordance with SAAMI-C.I.P. standards.

#### TO LOAD THE FIREARM

(1) Turn the lever locking latch to the release position. Releasing the latch should allow the lever to go down approximately 1/2". Do not push the lever forward. (Photos 1-2)

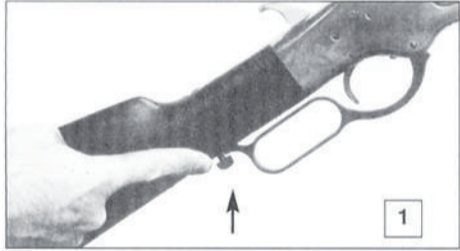

(2) First, make sure the lever is fully forward. (Photo 3). Then load the tubular magazine by pushing the brass magazine follower fully forward (Photo 4) until the engagement indicator just below the muzzle rises approximately 1/16th of an inch. (See photo 5).

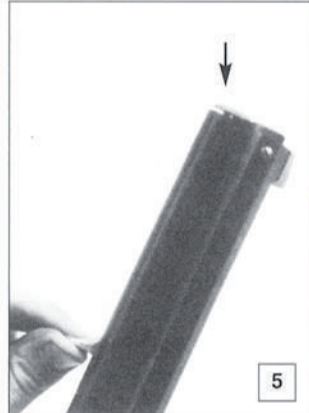
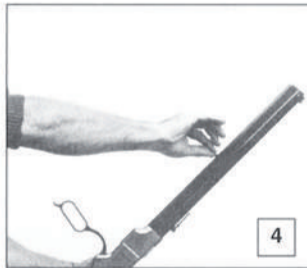

With the follower fully forward, the forward section of the barrel will rotate clockwise. (Photo 6).

If the barrel sleeve does not rotate, then the follower is not fully forward. Once the barrel sleeve has been rotated, insert the cartridges, rim first. (Photo 7). Hold the rifle pointed away from your face and at **an angle so that the cartridges slide slowly**

**down the magazine.** Capacity is 5 on the 16" Trapper, 6 on the 18" Trapper, 8 on the 22" Carbine and 10 on the 24" 1/4 Rifle.



N.	Code No.	Q.ty	Description	N.	Code No.	Q.ty	Description
1	0238001	1	Frame Assembly(1 + 73 + 74)	121	0238121	1	Band Screw
2	0200002	1	Hammer Assembly	124	0200124	2	Lever Spring Screw
3	0239003	1	Barrel 24 1/4" Cal.44-40	217	0238217	1	Butt Plate Gate
7	0238007	1	Carrier Block	223	0238223	1	Sleeve Assembly
10	0200010	1	Trigger	231	0238231	1	Butt Plate Gate Spring
15	0238015	1	Sight	232	0238232	1	Butt Plate Gate Spring Screw
19	0200019	1	Trigger Spring	237	0200237	1	Hook Lever Spring
20	0200020	1	Main Spring	263	0200263	1	Trigger Spring Screw
36	0200036	1	Main Spring Screw	458	0238458	1	Butt Plate Gate Pin
55	0238055	1	Rear Assembly	536	0238536	1	Sleeve Latch
57	0238057G	1	Rough Butt Stock	538	0238538	1	Sleeve Latch Rod Spring
58	0238057	1	Polished Butt Stock & Plate	540	0238540	1	Sleeve Tube
62	0200062	3	Butt Plate Screw	541	0238541	1	Sleeve Tube Pin
63	0200063	1	Tang Screw	542	0240542	1	Lever Hook
67	0200067	1	Firing Pin Extension	544	0238544	1	Rear Pin
69	0238069	1	Rear Base	545	0238545	2	Rear Sphere
73	0238073	1	Rough Rough Right Side Plate	546	0238546	1	Sleeve Latch Rod
74	0238074	1	Rough Rough Left Side Plate	550	0238550	1	Magazine Follower Screw
76	0238076	1	Rear Running	552	0000055	1	Hook Lever Spring Screw
79	0230079	1	Extractor Cal.45/Cal.44-40	600	0238600	1	Rear Sphere Spring
80	0238080	1	Front Band	609	0238609	1	Rear Running Block Screw
83	0220083	1	Right Rear Link	660	0238660	1	Rear Running Spring
84	0220084	1	Left Rear Link	721	0220721	1	Firing Pin Extension Stop
85	0220085	1	Right Front Link	735	0238735	1	Plastic Buffer
86	0220086	1	Left Front Link				
89	0200089	1	Lever				
90	0200090	1	Lifter Arm				
92	0200092	1	Right Lever Spring				
93	0200093	1	Left Lever Spring				
95	0070016	1	Firing Pin Spring				
96	0230096	1	Magazine Spring 20"				
97	0230097	1	Breech Block Cal.45/Cal.44-40				
98	0220098	1	Firing Pin				
99	0200099	1	Trigger Pin				
100	0200100	1	Hammer Pin Screw				
101	0200101	1	Lever Screw				
105	0200105	2	Rear Link Pin				
106	0200106	2	Link Pin				
107	0200107	1	Lever Pin				
108	0230108	1	Extractor Pin Cal.45/Cal.44-40				
112	0200112	1	Stirrup Pin				
113	0238113	1	Magazine Follower				
115	0200115	1	Hammer Stirrup				

#### ALTERNATIVES

N.	Code No.	Q.ty	Description
3	0238003	1	Barrel 22 1/4" Cal.44-40
3	0286003	1	Barrel 16 1/2" Cal.44-40
3	0287003	1	Barrel 18 1/2" Cal.44-41
3	0288003	1	Barrel 16 1/2" Cal.45LC
3	0290003	1	Barrel 16 1/2" Cal.45LC
3	0291003	1	Barrel 18 1/2" Cal.45LC
62	0200062	2	Swivel Screw
96	0223096	1	Magazine Spring 16 1/8"
321	0238321	1	Rear Swivel Pivot
348	0238348	2	Front Swivel Screw
519	0238519	1	Front Swivel
520	0238520	1	Rear Swivel
521	0238521	1	Rear Swivel Pin
543	0238543	1	Rear Swivel Base
747	0155629	1	Rear Swivel Pivot Circlip

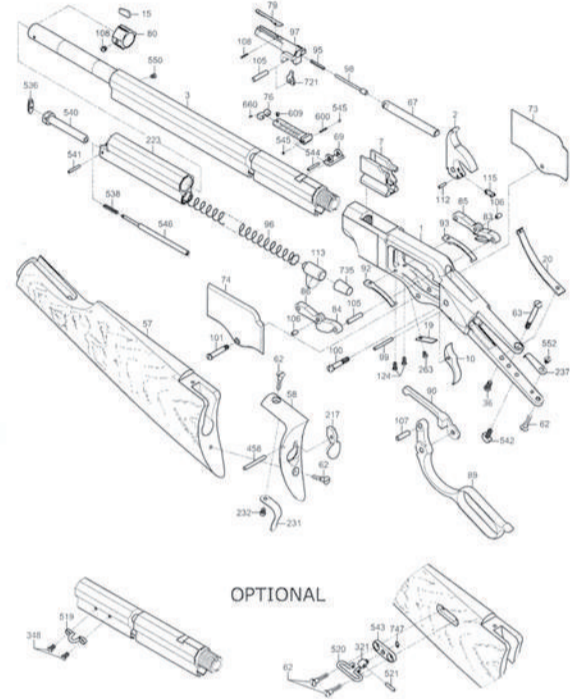

(3) Place your hand on the sleeve with thumb grasping the brass follower. Rotate the barrel sleeve back into the closed position and with thumb slowly allow follower to return downwards. **GENTLY LET THE FOLLOWER DOWN ONTO THE LOADED CARTRIDGE, ABSOLUTELY DO NOT LET IT SLAM.** DO NOT place any part of your hand over the muzzle while loading.



(4) When you are ready to actually fire the firearm, the lever is pushed forward as far as it will go and is then pulled straight back. Your finger should **NOT TOUCH THE TRIGGER** while manipulating the loading lever. (Photo 8).

The rifle will now be fully cocked and will fire when the trigger is pulled. If the lever does not go forward, release the lever latch by turning the small knob perpendicular to the rifle.

(5) After you have fired the first shot, the next cartridge is loaded by repeating step 4.

#### UNLOADING THE FIREARM

(6) With the firearm pointed in a safe direction, place your fingers through the rear portion of the loading lever. Be sure your first and second fingers are inside the lever loop. **DO NOT TOUCH THE TRIGGER**, depressing or touching the trigger, **EVEN WHEN THE LEVER IS FULLY OPEN OR PARTIALLY CLOSED**, may cause the gun to accidentally discharge and cause serious injury or death to you or anyone in the line of fire. Push the lever straight backward and then pull forward again. The cartridge that was in the chamber should now be automatically ejected. (Photo 9)



(7) Repeat step 6 until all cartridges have been ejected from the firearm. After all cartridges have been ejected, cycle the action four or five more times as described in step 6 as an added precaution to assure that all rounds were ejected.

(8) After step 7, move the lever to the forward position while visually inspecting **both the chamber and the carrier block**, to confirm that no cartridges are still in the firearm.

(9) Pull the lever to the rear and, with your thumb on the hammer, pull the trigger and gently lower the hammer.